

**MAX LIFTING HEIGHT**

**9,5 m**

n° 3 positions of stabilizers

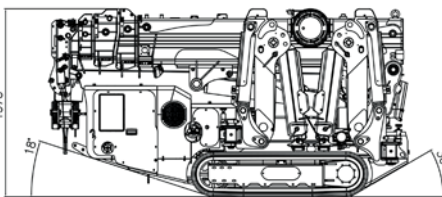
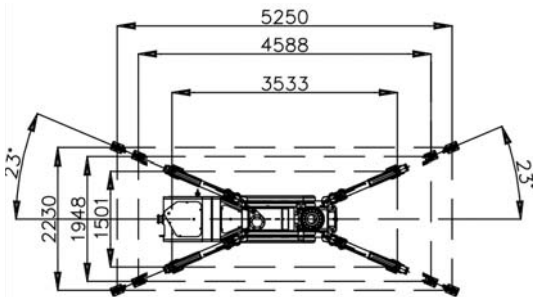
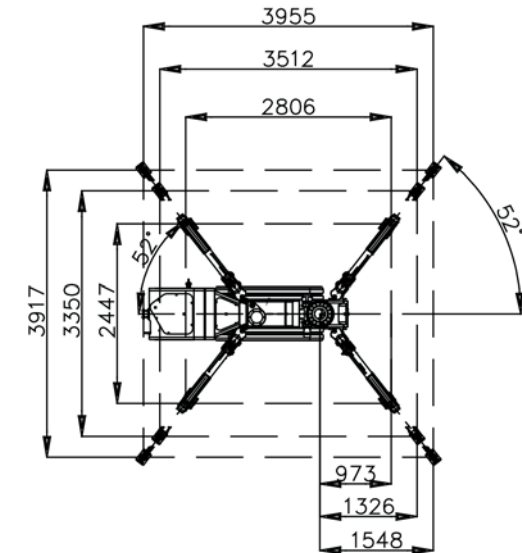
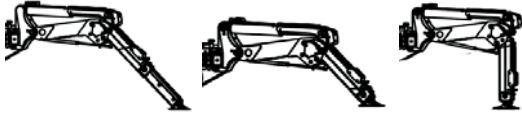

**CRANE CAPACITY**

**2,9 t x 1,5 m**

**WORKING RADIUS**

**8,7 m x 0,2 t**

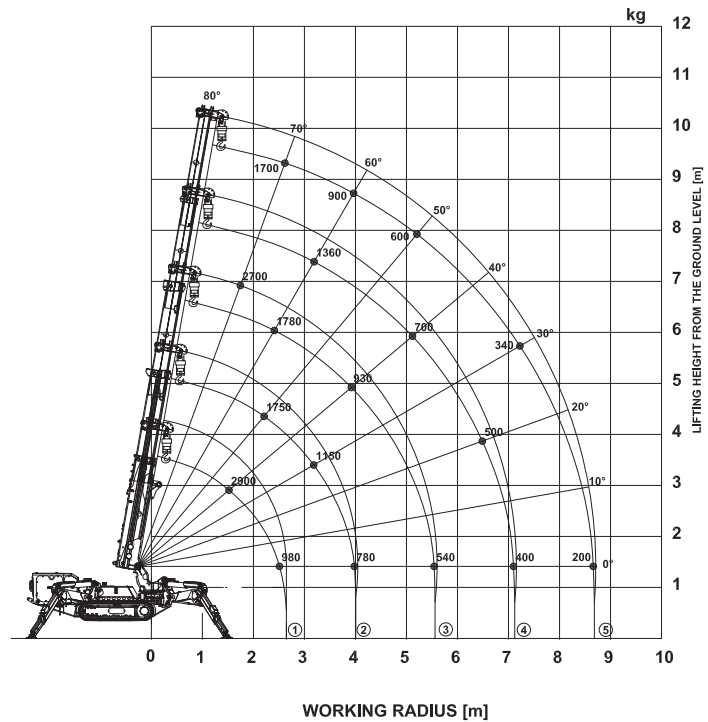
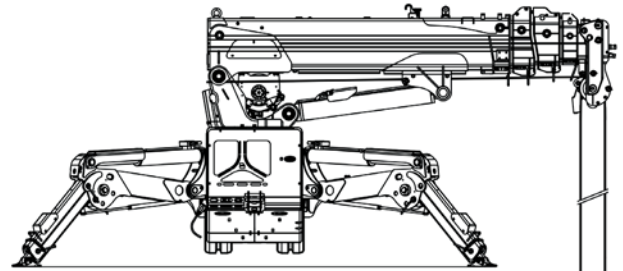

4 Fall  
13.12 m  
2900 kg max

2 Fall  
26.25 m  
2000 kg max

1 Fall  
53 m  
1000 kg max

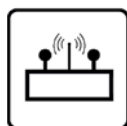
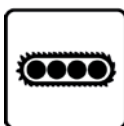
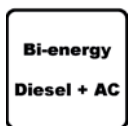
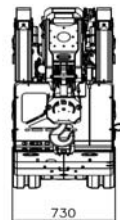
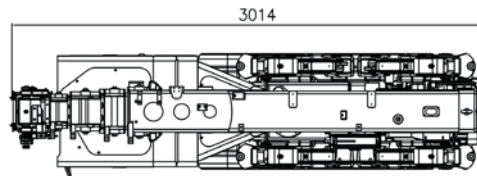

8,7 m

2,9t x 1,5m

53m  
(1 fall)

min 2,5m  
max 9,5m

-53m with  
1000kg  
load



endless

2,5 km/h

2300 kg

30%

21%

13,8 kN

11 kN/m<sup>2</sup>

3,5 t

**LOAD CAPACITIES FROM THE ROTATION CENTER**

**② SECOND STAGE EXTENDED BOOM LENGTH 2,2 m - 4 m**

up to	2,2m	3,5m	4m
max. extended	1750	1000	780

**③ THIRD STAGE EXTENDED BOOM LENGTH 4 - 5,5 m**

up to	2,5m	3m	3,5m	4m	4,5m	5m	5,5m
max. extended	1750	1600	1000	900	850	700	540

**④ FOURTH STAGE EXTENDED BOOM LENGTH 5,5 - 7,1 m**

up to	2,7m	3,5m	3,5m	4m	5m	5,5m	6,5m	7,1m
max. extended	2600	1200	1200	950	700	600	500	400

**⑤ FIFTH STAGE EXTENDED BOOM LENGTH 7,1 - 8,7 m**

up to	2,5m	3,5m	4m	4,5m	5m	6m	7m	8,7m
max. extended	1800	1200	900	750	700	550	430	200

**+ hydraulic jib**

**max lifting height  
12,5 m**

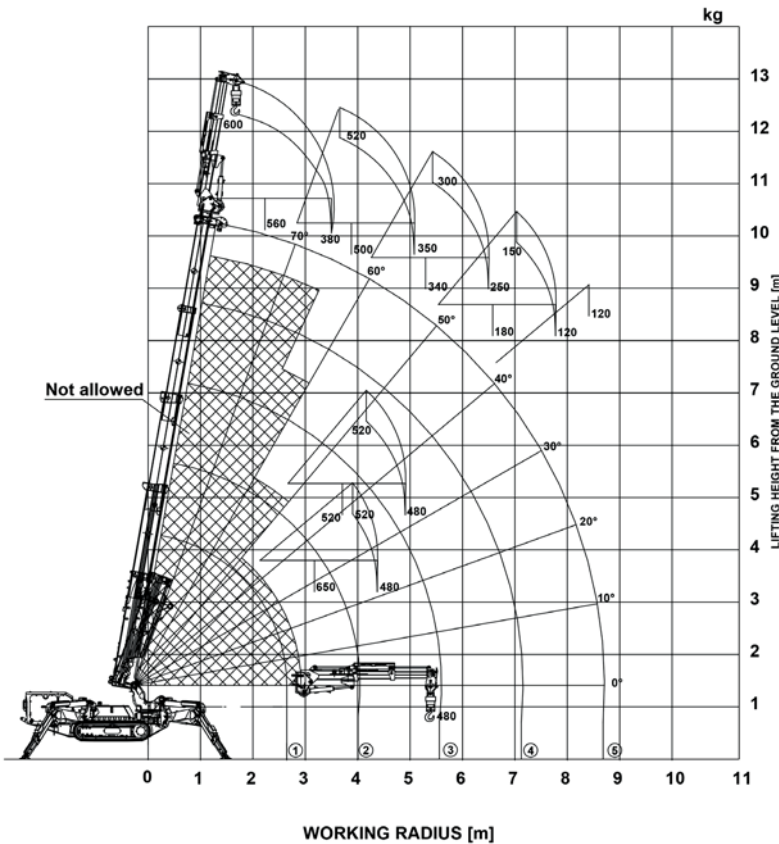

**2740 kg**



**min 9,5m  
max 12,5m**

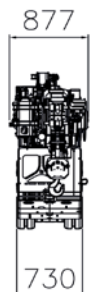
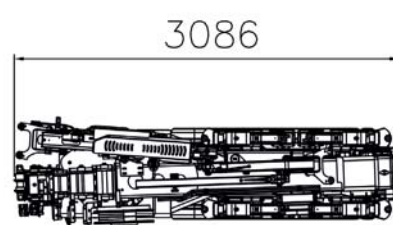
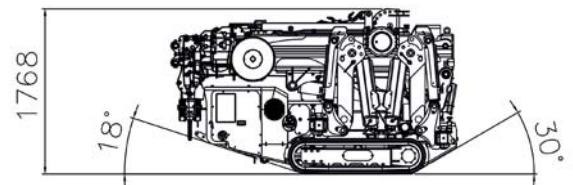

Characteristics and technical data are informative only and subjected to change without notice.

COMPANY WITH  
QUALITY SYSTEM  
CERTIFIED BY DNV GL  
= ISO 9001 =



Palazzani Industrie S.p.A. Via del Pavione, 4 - 25050 - Paderno F.C. (BS) - Italy  
Tel. (+39) 0306857073 platforms@palazzani.it www.palazzani.it

NC 690 A 20